

Linear

MIMI RGB Fixture Guide

KKDC

Indoor/Outdoor | Surface | RGB output



Key applications

- ✓ Architectural detail
- ✓ Bathrooms
- ✓ Building facades
- ✓ Cove lighting
- ✓ Direct lighting
- ✓ Exterior
- ✓ Hand rail
- ✓ Indirect lighting
- ✓ Special effect
- ✓ Wet area

Key features

- ✓ Adjustable
- ✓ Custom lengths
- ✓ Constant Voltage (CV)
- ✓ Diffusion: spotting
- ✓ IP44 moisture resistant
- ✓ IP67 waterproof
- ✓ Nano louvre
- ✓ RGB

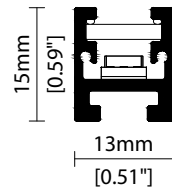

MOUNTING METHODS



KKCP-02 Clip



KKCP-14 Locking clip



KKBK-06 Fixed bracket



KKBK-05 Adjustable bracket



EB End Cap Bracket

Linear

MIMI RGB

Specification sheet



Dimensions	H15/W13/L103-2020mm* (H0.59/W0.51/L4.05-79.53in*) *Nano Louvre = 1020mm/40.16in Max
PCB Cut-point	83.3mm increment/2000mm* (3.28in increment/78.74in*) *Nano Louvre = 1000mm/39.37in Max
LED Pitch	13.9mm-72LED/m (0.55in - 22LED/ft)
Chip	RGB
Cover/Optics	Clear (75°)/Diffused (95°)/Nano louvre (35°)/Black (63°)
CCT	Red 620-625nm/Blue 455-460nm/Green 520-525nm
LED binning	5nm tolerance
CRI	N/A
Lifetime	50,000 hours @ 25°C (50,000 hours @ 77°F)
Operating temp	T _a = -25 to 55°C (T _c max = 70°C) T _a = -13 to 131°F (T _c max = 158°F)
IP Rating	IP44/IP67
Finish	Silver anodised
Mounting	Surface mounting via clips or brackets
Power feed	Sheathed hardwire tails or male/female connectors
Control	DMX/DALI



Power consumption	Supply voltage	Supply current
15.6W/m (4.75W/ft)	24V DC	0.65A/m (0.20A/ft)

Clear	Diffused	Diffused + Nano Louvre	Black
Red: 98lm/m (30lm/ft)	Red: 80lm/m (24lm/ft)	Red: 21lm/m (6lm/ft)	Red: 58lm/m (18lm/ft)
Green: 210lm/m (64lm/ft)	Green: 172lm/m (52lm/ft)	Green: 44lm/m (13lm/ft)	Green: 126lm/m (38lm/ft)
Blue: 35lm/m (11lm/ft)	Blue: 29lm/m (9lm/ft)	Blue: 7lm/m (2lm/ft)	Blue: 21lm/m (6lm/ft)
RGB: 305lm/m (93lm/ft)	RGB: 250lm/m (76lm/ft)	RGB: 64lm/m (19lm/ft)	RGB: 183lm/m (56lm/ft)

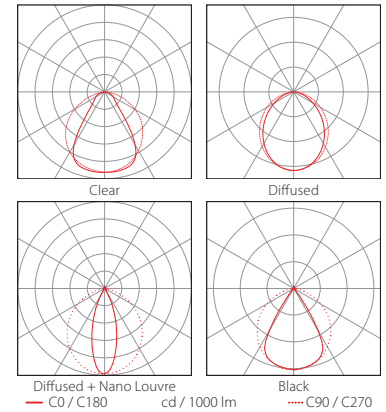
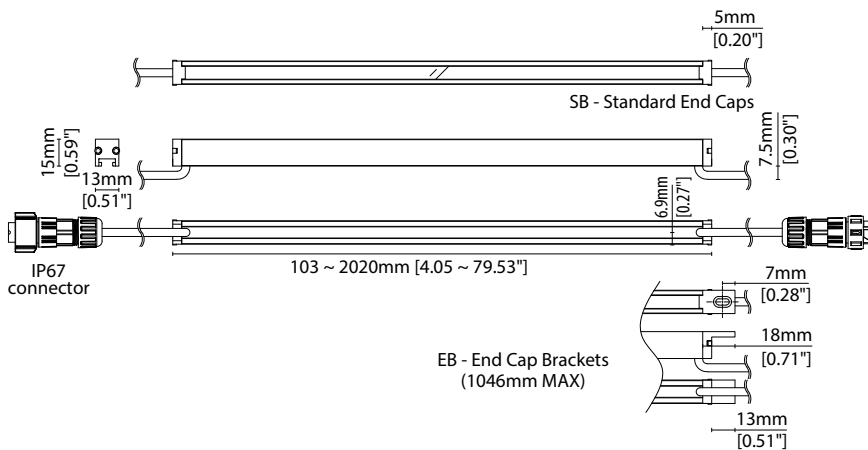

Data derived from production samples tested to UKAS/IESNA LM-79-08 standards.

See KKDC website for product document updates.

www.kkdc.lighting

MIMIRGBS-03.04EN-20250103

FIXTURE

Model	Finish	Cover ¹	Grade	LED	Colour (CCT)	Length Availability ²	IP	Cable Length	Power Feed ³	Fixing	Input
MIMI MI	Silver Anodised SA	Clear B Diffused C Diffused + Nano Louvre ^{4,5} CN Black Y	s	501 501	RGB RGB	m 103.3-2020mm 83.3mm increments i 4.07-79.53in 3.28in increments (Specify length code OR total run length)	IP44 44 IP67 ⁶ 67	300mm/11.81" 0300	Single ø4.3mm sheath tail S00A Double ø4.3mm sheath tail D00A Single ø4.3mm sheath IP67 connector S67A Double ø4.3mm sheath IP67 connector D67A	Standard End Cap SB End Cap Bracket EB	DC 24V g

¹ Refer to **Cover Options** on **Options** pages ² Refer to **Length Availability List** or enter total run length instead of length code ³ Refer to **Power Feed Options** on **Options** pages
⁴ Max length available with Nano Louvre is 1020mm
⁵ Nano Louvre suitable for IP44 variant ONLY. Prolonged exposure to water droplets on cover surface may result in superficial peeling of Nano louvre film without affecting integrity of housing ingress
⁶ Due to the clear, flush potted polyurethane top layer on IP67 MIMI a colour shift of +/-20K should be expected

Code Example:

MI	-	SA	-	CN	-	s	-	501	-	RGB	-	m	-	520	-	67	-	0300	-	S00A	-	EB	-	g
MIMI		Silver Anodised		Diffused + Nano Louvre				501		RGB		520mm		IP67		300mm/11.81"		Single ø4.3mm sheath tail		End Cap Bracket		DC 24V		

ACCESSORIES

Mounting Accessories

KKCP-02	Clip (1no.)
KKCP-52	Clip (500no.)
KKCP-14	Lock Clip
KKBK-06	Fixed bracket
KKBK-05	Adjustable bracket

* Refer to **Mounting accessories** on **Accessories** pages

Connection Accessories

CN67-4P-0300	IP67 4 PIN RGB male & female 300mm/11.81" pair
CN67-4P-1000	IP67 4 PIN RGB male & female 1000mm/39.37" pair
CN67-4P-3000	IP67 4 PIN RGB male & female 3000mm/118.11" pair

* Refer to **Power feed** on **Accessories** pages

Exterior Junction Boxes

KKJB-07	IP67 Slim J-Box
KKJB-07R	Potting Resin for IP67 Slim J-Box

* Refer to **Exterior Junction Boxes** on **Accessories** pages

PSU/Driver

0-10V/1-10V/DALI/DMX

* Refer to **Driver/PSU Options** page for details or provide requirement and KKDC to offer the suitable option

LED ENGINE VARIANTS (LED STRIP TYPE)

Colour	LED	Lumen/m	Lumen/ft	W/m	W/ft	Spec Doc	Length	Increment
Single CCT	R007	475	145	7	2.13	MIMI R007	103-2020mm (4.05-79.53in)	41.7mm (1.64in)
	A010	920	280	10	3.05	MIMI A010	97-2020mm (3.82-79.53in)	38.46mm (1.51in)
	R014	979	299	14	4.27	MIMI R014	103-2020mm (4.05-79.53in)	41.7mm (1.64in)
	R020	1208	368	20	6.10	MIMI R020	103-2020mm (4.05-79.53in)	41.7mm (1.64in)
	A020	1840	561	20	6.10	MIMI A020	97-2020mm (3.82-79.53in)	38.46mm (1.51in)
	Warm Dim/Dynamic White	R207	984	300	16	4.88	MIMI R207	103-2020mm (4.05-79.53in)
RGB	501	Red 98 Green 210 Blue 35 RGB 305	Red 30 Green 64 Blue 11 RGB 93	15.6	4.75	MIMI RGB	103-2020mm (4.05-79.53in)	83.3mm (3.28in)

* Performance data: clear cover, RGB

Length Code		Fixture Length ¹		LED Strip ²		End Cap Dimension ³		Wattage (W)	Output (lm)			
Metric	Imperial(US)	Metric	Imperial(US)	Metric	Imperial(US)	Metric	Imperial(US)		R	G	B	W
m0103	i0004	103mm	4.07in	83mm	3.28in	10mm	0.39in	1.30	8	18	3	25
m0187	i0007	187mm	7.35in	167mm	6.56in	10mm	0.39in	2.60	16	35	6	51
m0270	i0011	270mm	10.63in	250mm	9.84in	10mm	0.39in	3.90	25	53	9	76
m0353	i0014	353mm	13.91in	333mm	13.12in	10mm	0.39in	5.20	33	70	12	102
m0437	i0017	437mm	17.19in	417mm	16.41in	10mm	0.39in	6.50	41	88	15	127
m0520	i0020	520mm	20.47in	500mm	19.69in	10mm	0.39in	7.80	49	105	18	153
m0603	i0024	603mm	23.76in	583mm	22.97in	10mm	0.39in	9.10	57	123	20	178
m0687	i0027	687mm	27.04in	667mm	26.25in	10mm	0.39in	10.40	65	140	23	203
m0770	i0030	770mm	30.32in	750mm	29.53in	10mm	0.39in	11.70	74	158	26	229
m0853	i0034	853mm	33.60in	833mm	32.81in	10mm	0.39in	13.00	82	175	29	254
m0937	i0037	937mm	36.88in	917mm	36.09in	10mm	0.39in	14.30	90	193	32	280
m1020	i0040	1020mm	40.16in	1000mm	39.37in	10mm	0.39in	15.60	98	210	35	305
m1103	i0043	1103mm	43.44in	1083mm	42.65in	10mm	0.39in	16.90	106	228	38	330
m1187	i0047	1187mm	46.72in	1167mm	45.94in	10mm	0.39in	18.20	114	245	41	356
m1270	i0050	1270mm	50.00in	1250mm	49.22in	10mm	0.39in	19.50	123	263	44	381
m1353	i0053	1353mm	53.29in	1333mm	52.50in	10mm	0.39in	20.80	131	280	47	407
m1437	i0057	1437mm	56.57in	1417mm	55.78in	10mm	0.39in	22.10	139	298	50	432
m1520	i0060	1520mm	59.85in	1500mm	59.06in	10mm	0.39in	23.40	147	315	53	458
m1603	i0063	1603mm	63.13in	1583mm	62.34in	10mm	0.39in	24.70	155	333	55	483
m1687	i0066	1687mm	66.41in	1667mm	65.62in	10mm	0.39in	26.00	163	350	58	508
m1770	i0070	1770mm	69.69in	1750mm	68.90in	10mm	0.39in	27.30	172	368	61	534
m1853	i0073	1853mm	72.97in	1833mm	72.18in	10mm	0.39in	28.60	180	385	64	559
m1937	i0076	1937mm	76.25in	1917mm	75.47in	10mm	0.39in	29.90	188	403	67	585
m2020	i0080	2020mm	79.53in	2000mm	78.75in	10mm	0.39in	31.20	196	420	70	610

¹ Actual total overall length of light fixture (LED strip + end caps + void/wire hole)

² Actual length of PCB strip

³ Actual length of 2x end caps

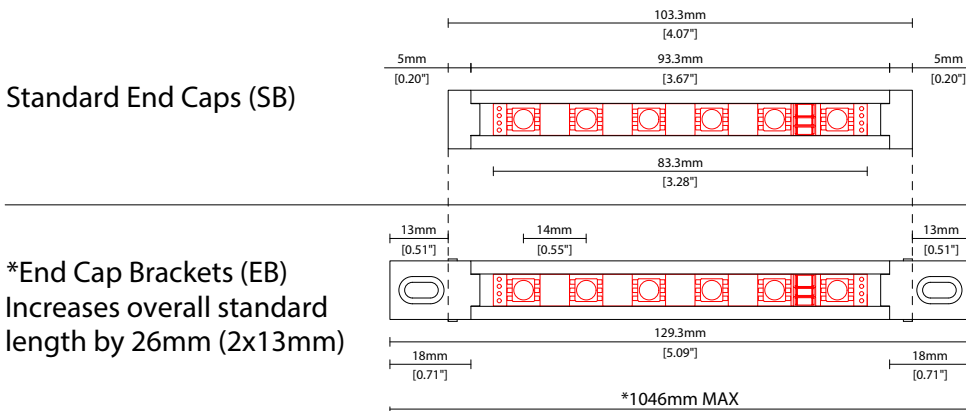

***IMPORTANT NOTE:**
DUE TO POTENTIAL PROFILE 'SAGGING' THE MAX LENGTH AVAILABLE WITH END CAP BRACKETS IS 1046mm.

Linear

MIMI RGB Options

KKDC

COVER OPTIONS

* Options are an integral part of the fixture ordering codes. Please refer to **Code Table** pages.

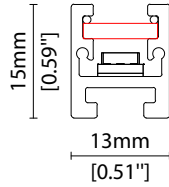

B Clear Cover
Polycarbonate
W13/H15mm (W0.51"/H0.59")

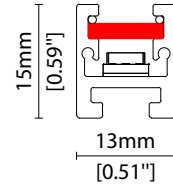

C Diffused Cover
Polycarbonate finish
W13/H15mm (W0.51"/H0.59")

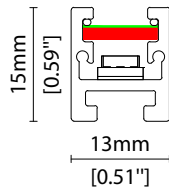

CN Diffused Cover + Nano Louvre
Polycarbonate cover with anti-glare, 30° cut-off view angle
W13/H15mm (W0.51"/H0.59")

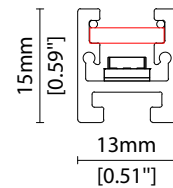
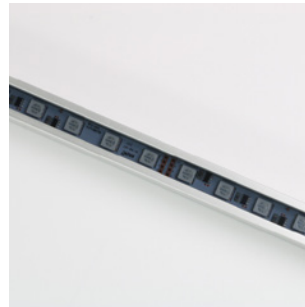

Y Black Clear Cover
Dark tinted translucent polycarbonate
60% light output
W13/H15mm (W0.51"/H0.59")

END CAP OPTION

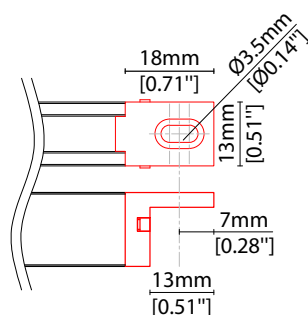

EB End Cap Bracket (Pair)
Handrail installation
Compatible up to 1m/40"
L18/W13/H15mm
(L0.7/W0.51/H0.59")

POWER FEED OPTIONS

0300 S00A 300mm (11.81") Single Ø4.3mm sheath tail

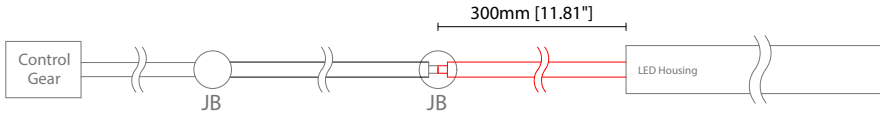

0300 D00A 300mm (11.81") Double Ø4.3mm sheath tail

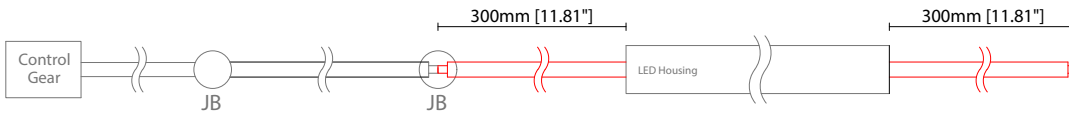

0300 S67A 300mm (11.81") Single Ø4.3mm sheath connector IP67 (Premoulded)

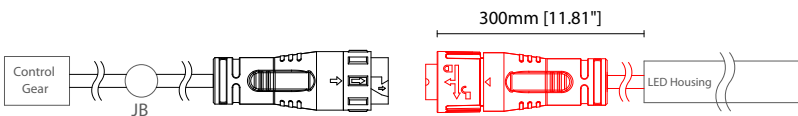

0300 D67A 300mm (11.81") Double Ø4.3mm sheath connector IP67 (Premoulded)

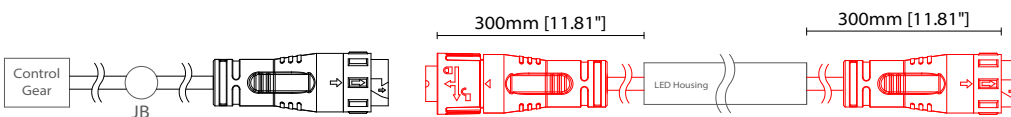

4 Pin RGB Female Connector IP67 (Premoulded)

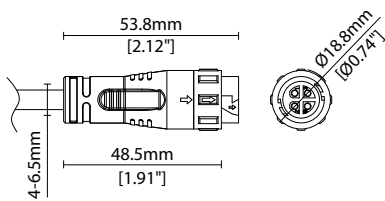

4 Pin RGB Male Connector IP67 (Premoulded)

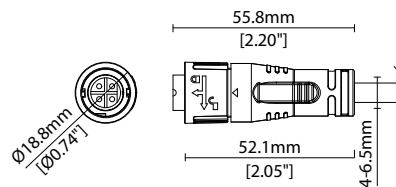

Key

Control Gear Power supply, sub-controllers & control systems

JB Junction box / cable connection

MOUNTING ACCESSORIES

Note: Accessories are to be ordered separately with corresponding code shown below.

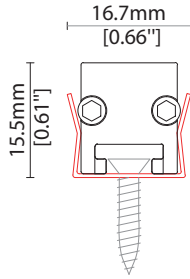

KKCP-02 (1no.)
KKCP-52 (500no.)
Clip (allow 3 per metre/40in)
S/Steel finish
L25/W16.7/H15.5mm
(L0.98/W0.66/H0.61")

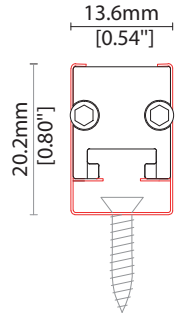

KKCP-14
Lock clip (allow 2 per metre/40in)
S/Steel finish
L25/W14/H21mm
(L0.98/W0.55/H0.83")

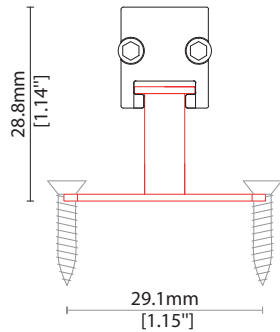

KKBK-06
Fixed bracket (allow 3 per metre/40in)
S/Steel finish
L20/W29.1/H28.8mm
L0.79/W1.15/H1.13"

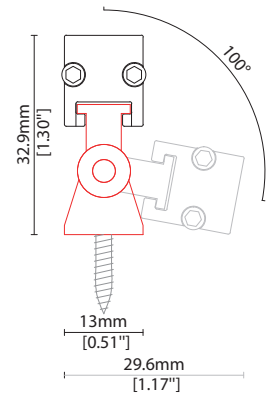

KKBK-05
Adjustable bracket
(allow 2 per metre/40in)
S/Steel finish
W13/H32.9mm
W0.51/H1.3"

POWER FEED

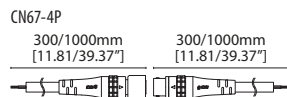

CN67-4P-0300 300mm (11.81in) pair
CN67-4P-1000 1000mm (39.37in) pair
IP67
4 PIN male + female (RGB/LEDmix) connector set



CN67-4P-3000 3000mm (118.11in) pair
IP67
4 PIN male + female (RGB/LEDmix) connector set

EXTERIOR JUNCTION BOXES



KKJB-07

IP67 Slim J-Box
(including type A,B,C, D bushings)



KKJB-07R

Potting resin for IP67 Slim J-Box

KKDC CONTROL



KKDM-06 1-10V

visDIM dimmable sub-controller
(4 x 8A max @ 12-36V)

IP20
Plastic housing
L170/W59/H29mm
(L6.69/W2.32/H1.14in)



KKSC-05 DMX

visDIM dimmable sub-controller
(4 x 5A max @ 12-36V)

IP20
Plastic housing
L170/W53.4/H28mm
(L6.69/W2.10/H1.10in)



KKDL-02 DALI

visDIM dimmable sub-controller
(4 x 8A max @ 12-36V)

IP20
Plastic housing
L170/W59/H29mm
(L6.69/W2.32/H1.14in)



KKDL-03 DALI

visDIM dimmable sub-controller
(4 x 5A max @ 12-36V)

IP20
Plastic housing
L166/W53.4/H23mm
(L6.54/W2.10/H0.91in)

AVAILABLE PSU OPTIONS

Control Mode	PSU (Order Code)	Input Voltage AC	Output Voltage DC	Rated Output Current	Rated Power	Dim %	IP Rating
Switched	CEN-60-24	90-295V	24V	2.5A	60W	-	IP67
	HLG-60H-24	90-305V	24V	2.5A	60W	-	IP67
	HLG-100H-24	90-305V	24V	4.0A	100W	-	IP67
	HLG-150H-24	90-305V	24V	6.3A	150W	-	IP67
	HLG-240H-24	90-305V	24V	10A	240W	-	IP67
0-10V (1-10V)	PWM-40-24	90-305V	24V	1.67A	40W	100-0.15 (100-10)	IP67
	PWM-60-24	90-305V	24V	2.5A	60W	100-0.15 (100-10)	IP67
	PWM-90-24	90-305V	24V	3.67A	90W	100-0.15 (100-10)	IP67
	PWM-120-24	90-305V	24V	5.0A	120W	100-0.15 (100-10)	IP67
DALI	LIN100A1	120-277V	24V	1A per channel	100W	100-0.1	IP66/IP40
DMX RGB	LIN100A1	120-277V	24V	1.33A per channel	100W	100-0.1	IP66/IP40
DMX RGBW	LIN100A1	120-277A	24V	1A per channel	100W	100-0.1	IP66/IP40

Flicker Free Options - Combination of PSU+ sub-controller

Control Mode	PSU (Order Code)	Sub-controller (Order Code)	Input Voltage AC	Output Voltage DC	Rated Output Current	Rated Power	Dim %	IP Rating PSU/ Sub-controller
0-10V or 1-10V	CEN-60-24	KKDM-06	90-295V	24V	2.5A	60W	100-0.9	IP67/IP20
	HLG-60H-24	KKDM-06	90-295V	24V	2.5A	60W	100-0.9	IP67/IP20
	HLG-100H-24	KKDM-06	90-295V	24V	4.0A	100W	100-0.9	IP67/IP20
	HLG-150H-24	KKDM-06	90-295V	24V	6.3A	150W	100-0.9	IP67/IP20
	HLG-240H-24	KKDM-06	90-295V	24V	10.0A	240W	100-0.9	IP67/IP20
DALI	CEN-60-24	KKDL-02/03	90-295V	24V	2.5A	60W	100-0.1	IP67/IP20
	HLG-60H-24	KKDL-02/03	90-305V	24V	2.5A	60W	100-0.1	IP67/IP20
	HLG-100H-24	KKDL-02/03	90-305V	24V	4.0A	100W	100-0.1	IP67/IP20
	HLG-150H-24	KKDL-02/03	90-305V	24V	6.3A	150W	100-0.1	IP67/IP20
	HLG-240H-24	KKDL-02/03	90-305V	24V	10.0A	240W	100-0.1	IP67/IP20
DMX RGB	CEN-60-24	KKSC-05	90-295V	24V	2.5A	60W	100-0.9	IP67/IP20
	HLG-60H-24	KKSC-05	90-305V	24V	2.5A	60W	100-0.9	IP67/IP20
	HLG-100H-24	KKSC-05	90-305V	24V	4A	100W	100-0.9	IP67/IP20
	HLG-150H-24	KKSC-05	90-305V	24V	6.3A	150W	100-0.9	IP67/IP20
	HLG-240H-24	KKSC-05	90-305V	24V	10.0A	240W	100-0.9	IP67/IP20

¹ The items shown above cover the most frequently used specification but does not exhaust the possible options

² PSU and/or driver can be chosen from the table, or KKDC may recommend the best option upon receipt of the controls requirement and installation environment

³ Electrical shop drawing will include detailed information of PSU and relevant control drivers

⁴ Cut sheets are available on the controls section of www.kkdc.lighting or upon request